

Article number: 12307200100110

Description: KLEE-coil 307 200 100.110

M10 Hardened/zinc-plated steel with hexagon

Measures

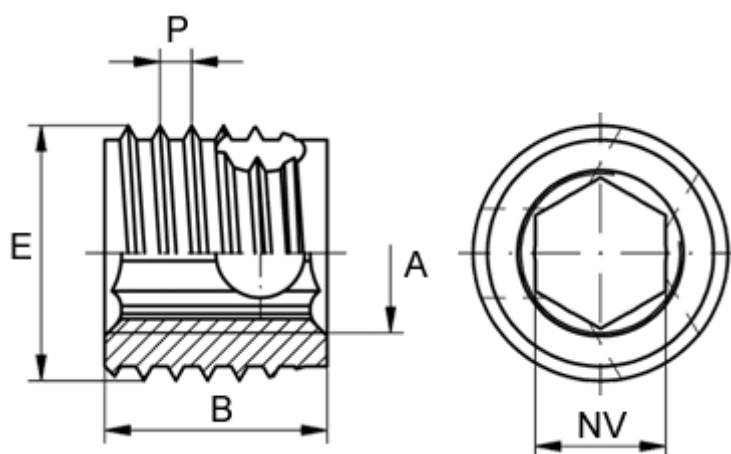

Female thread A	= M10
Length B	= 10
Male thread E	= 14
Min hole depth blind hole	= 16
Min material thickness	= 10
sw	= -
Thread pitch P	= 1.5
Type	= 307 200 100 ...